

川崎市雨水浸透柵2号

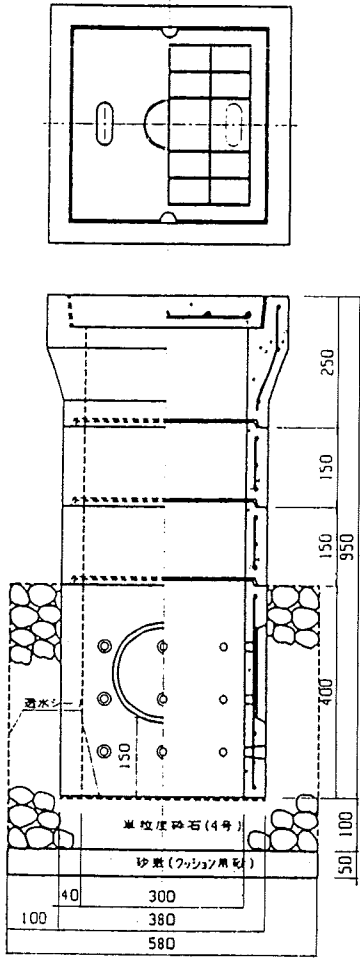

蓋 (T-6)

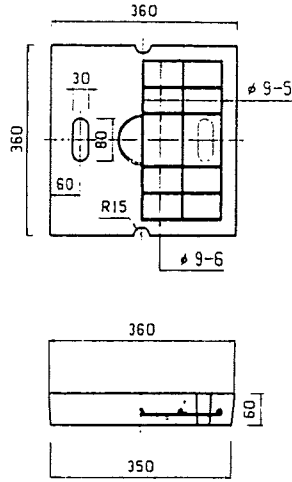

蓋 (T-14)
(鋼鉄棒付コンクリート製)

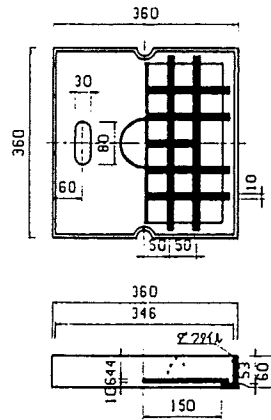

上部側塊

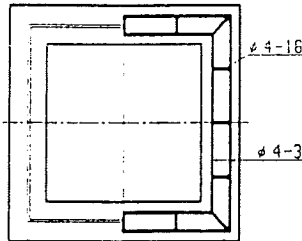

中部側塊

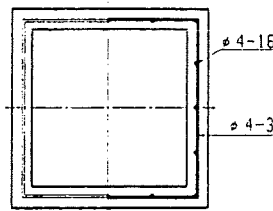

下部側塊

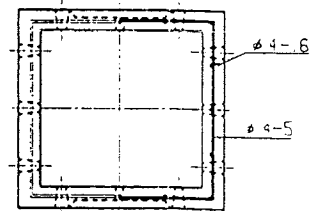

(T-6)

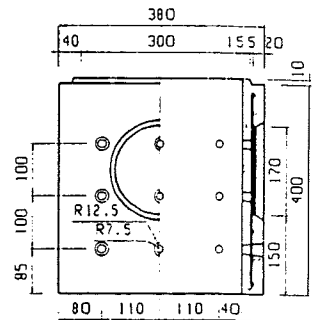
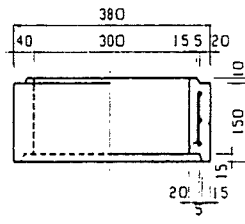
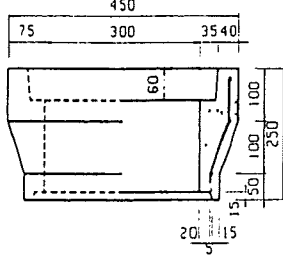

(T-14)

