

多孔浸透柵KCホール50

コンクリートふた

M45CC-05

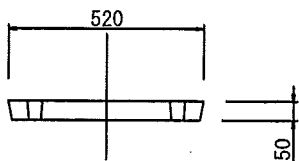
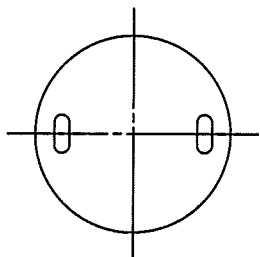

縁塊

M50KR-20

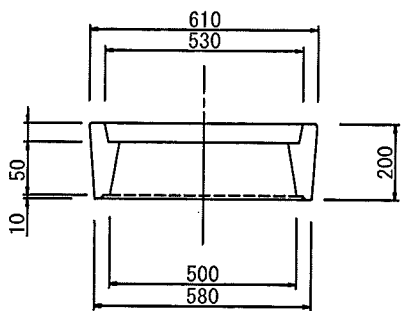
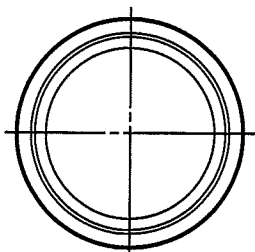

鋳鉄蓋

M45TC-05

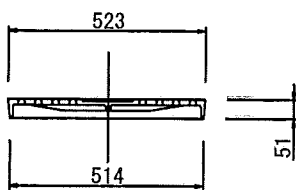
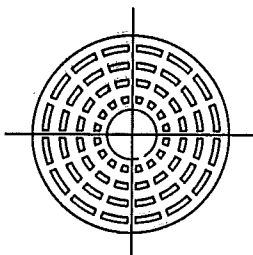

多孔側塊

M50A-30

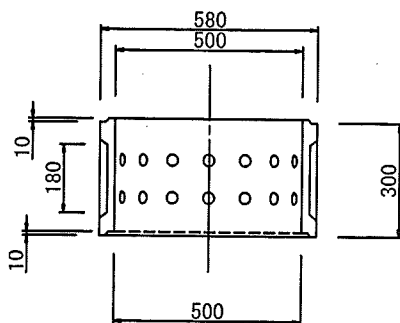
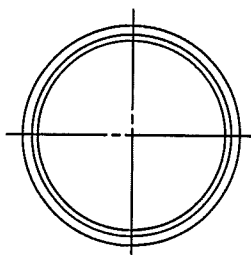

底塊

M50BP-5

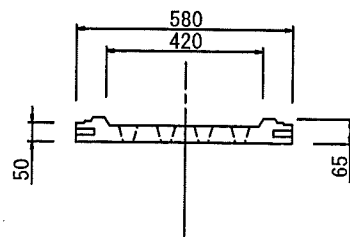
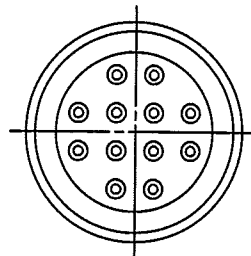

M50A-40

